

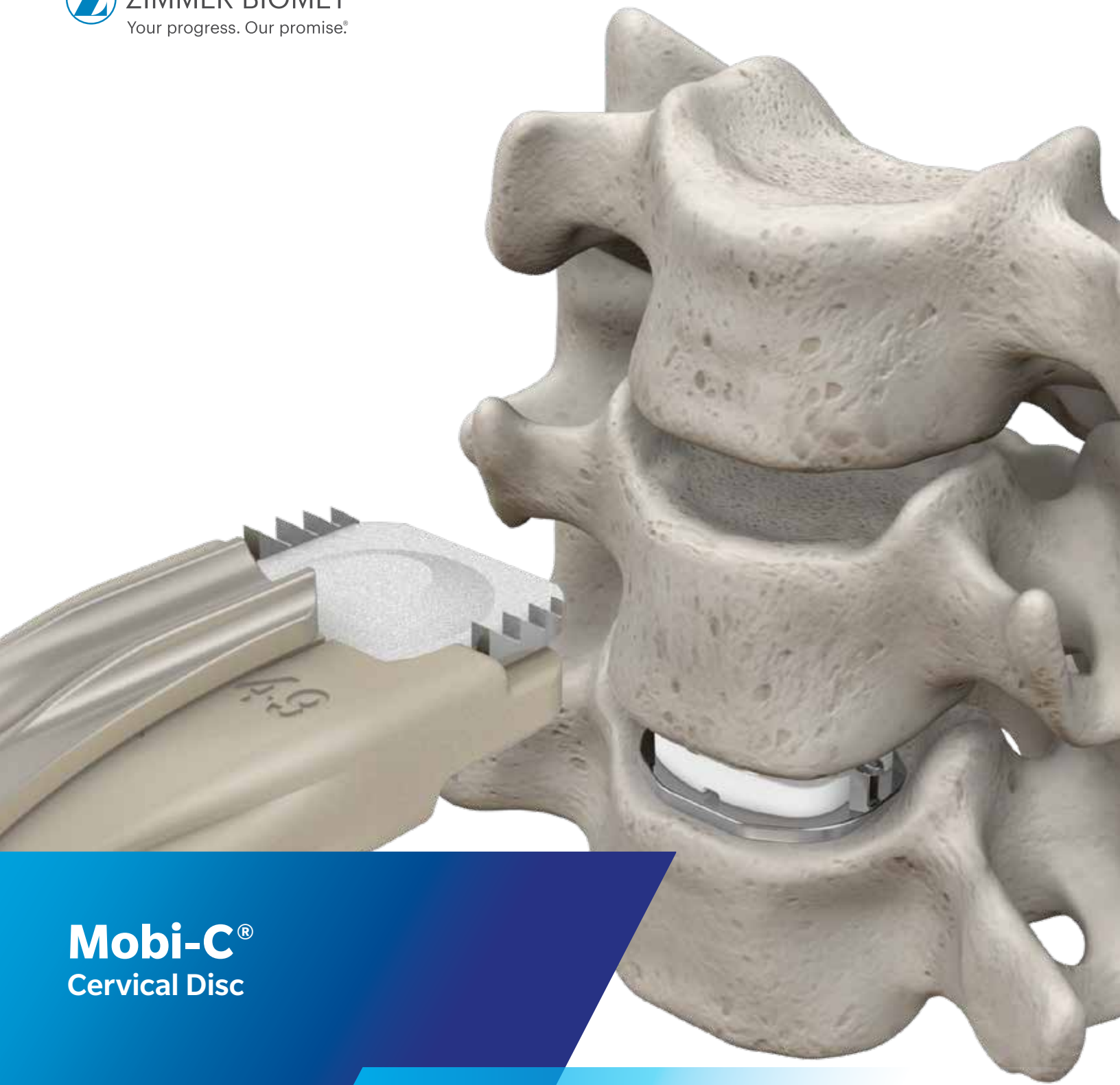

ZIMMER BIOMET
Your progress. Our promise.®



Mobi-C[®]
Cervical Disc

Surgical Technique Guide

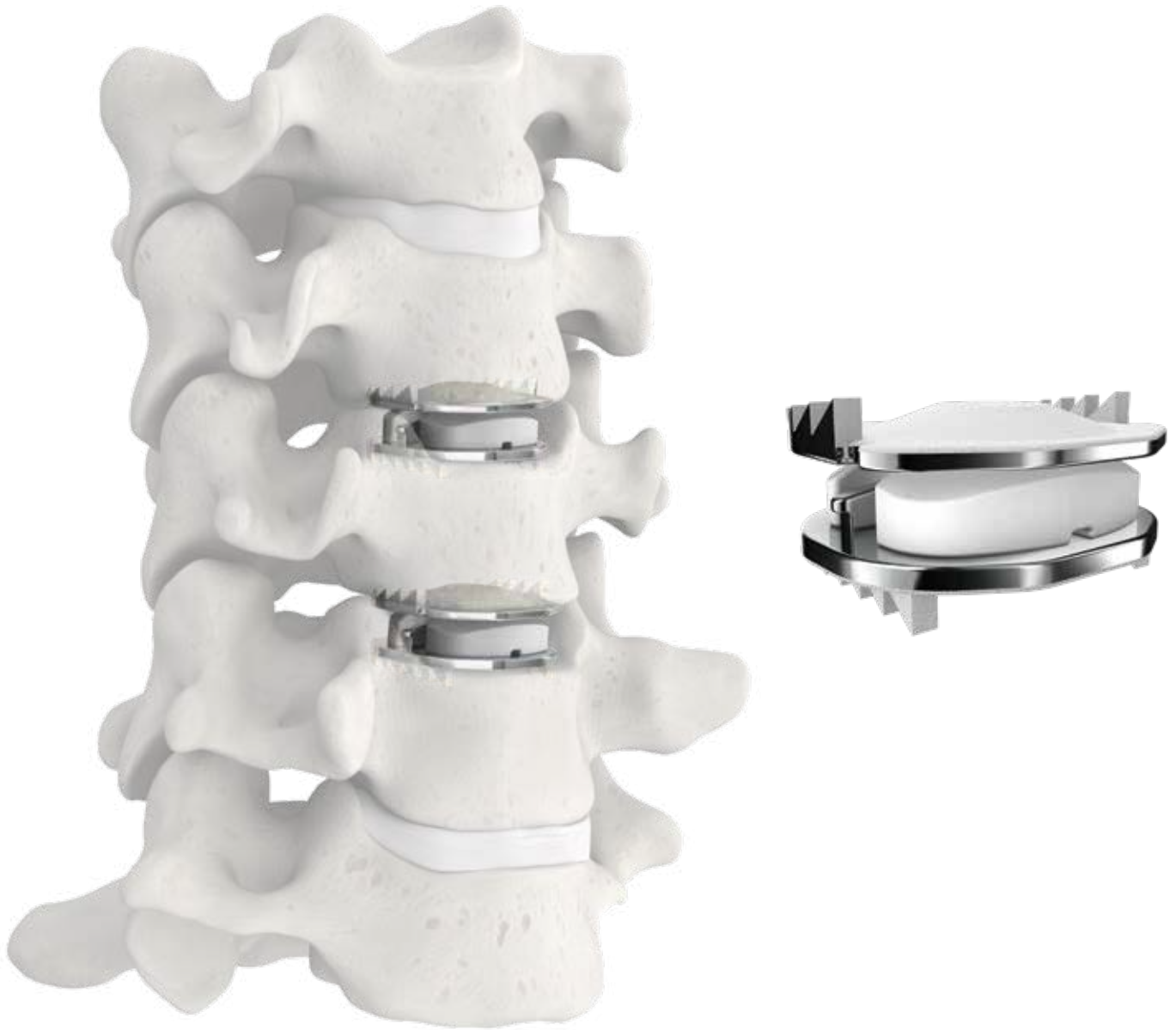

TABLE OF CONTENTS

System Overview	4
Surgery Preparation and Approach	6
Discectomy	8
Distraction	10
Trialing	11
Mobi-C Insertion	14
Removal of PEEK® Cartridge and Position Assessment	18
Second Implant Insertion	21
Implant Removal for Revision	22
Postoperative Management	23
Implant Kit	24
Instrument Set	25
Instrument Set: Cervical Distraction System	27
Important Information on the Mobi-C Cervical Disc	28

Zimmer Biomet Spine does not practice medicine. This technique was developed in conjunction with health care professionals. This document is intended for surgeons and is not intended for laypersons. Each surgeon should exercise his or her own independent judgment in the diagnosis and treatment of an individual patient, and this information does not purport to replace the comprehensive training surgeons have received. As with all surgical procedures, the technique used in each case will depend on the surgeon's medical judgment as the best treatment for each patient. Results will vary based on health, weight, activity and other variables. Not all patients are candidates for this product and/or procedure.

SYSTEM OVERVIEW

MOBI-C: PRODUCT DETAILS

Indications

The Mobi-C Cervical Disc Prosthesis is indicated in skeletally mature patients for reconstruction of the disc from C3 to C7 following discectomy at one or two contiguous levels for intractable radiculopathy (arm pain and/or a neurologic deficit) with or without neck pain or myelopathy due to abnormality localized to the level of the disc space and at least one of the following conditions confirmed by radiographic imaging (CT, MRI, X-rays): herniated nucleus pulposus,

spondylosis (defined by the presence of osteophytes), and/or visible loss of disc height compared to adjacent levels. The Mobi-C Cervical Disc Prosthesis is implanted using an anterior approach. Patients should have failed at least 6 weeks of conservative treatment or demonstrated progressive signs or symptoms despite nonoperative treatment prior to implantation of the Mobi-C Cervical Disc Prosthesis.

Sizing Options (set MWU)

DEPTH × WIDTH (mm)	HEIGHT (mm)
13 × 15	5, 6 and 7
13 × 17	
15 × 15	
15 × 17	
15 × 19	
17 × 17	
17 × 19	



IDE Success Criteria

Overall Trial Success

Trial success was based on a composite endpoint. A patient was considered a success at 60 months if all of the following criteria were met:

- Sufficient NDI improvement (≥ 15 points in subjects with baseline ≥ 30 points, or $\geq 50\%$ improvement in subjects with baseline < 30 points)
- No subsequent surgery at the treated level
- No major complications defined as:
 - No radiographic failure
 - No neurologic deterioration
 - No adverse event determined to be a major complication

Adjacent Segment Degeneration

Adjacent segment degeneration was assessed at the spinal segment immediately above and below the treated levels. An independent core laboratory assessed degeneration using the Kellgren-Lawrence 5-point grading scale.* An adjacent segment was counted as having degenerated if the segment worsened by 1 grade or more.

Subsequent Surgeries at the Treated Levels

The treatment was considered a success in terms of subsequent surgery if none of the following were necessary at either of the treated levels: removal, revision, reoperation or supplemental fixation.

***Note:** The Kellgren-Lawrence scale looks at radiographs for evidence of disc degenerative changes, including the absence or presence of osteophytes, disc narrowing, and endplate sclerosis. The five grades are: none (0), minimal (1), definite (2), moderate (3) or severe (4).

MOBI-C IS THE FIRST APPROVED TWO-LEVEL DISC¹

Mobi-C Is Non-inferior to ACDF at One-level and Superior at Two-levels²

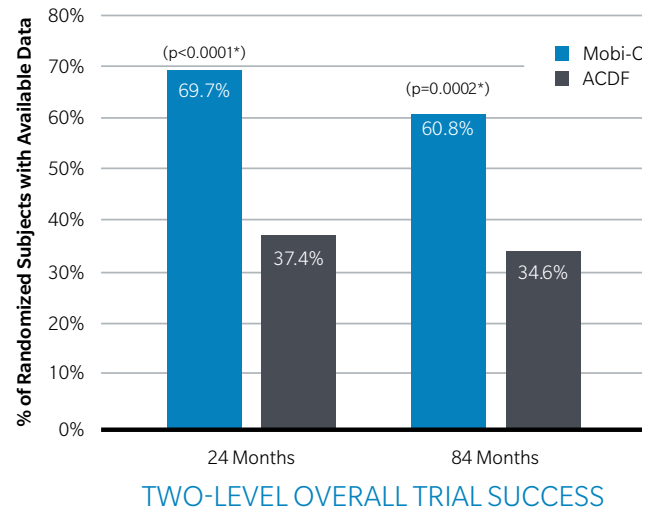
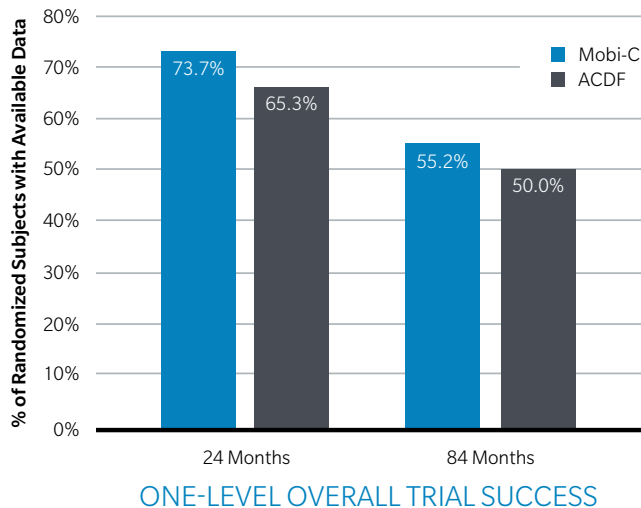

*Fisher's Exact test was used to compare treatments to establish superiority.

Mobi-C Had Lower Rates of Adjacent Segment Degeneration at 84 Months

The ONE-LEVEL deterioration of adjacent segments at 84 months compared to baseline was:

- 43.8% for Mobi-C compared to 63.0% for ACDF at the inferior level.
- 40.4% for Mobi-C compared to 65.1% for ACDF at the superior level.

The TWO-LEVEL deterioration of adjacent segments at 84 months compared to baseline was:

- 30.3% for Mobi-C compared to 66.7% for ACDF at the inferior level.
- 37.5% for Mobi-C compared to 73.7% for ACDF at the superior level.

Mobi-C Had Fewer Subsequent Surgeries at 84 Months

ONE-LEVEL: Only 3.4% of one-level Mobi-C patients compared to 11.1% of ACDF patients reported subsequent surgeries at the index levels through 84 months.

TWO-LEVEL: Only 5.6% of two-level Mobi-C patients compared to 17.1% of ACDF patients reported subsequent surgeries at the index levels through 84 months.

SURGERY PREPARATION AND APPROACH

Patient Selection

- See the indications, contraindications and other patient selection details in the device description and instructions for use guidelines at the end of this document.
- A minimal anteriorposterior (A/P) depth of 14 mm at the affected level is required and should be verified by X-ray preoperatively.

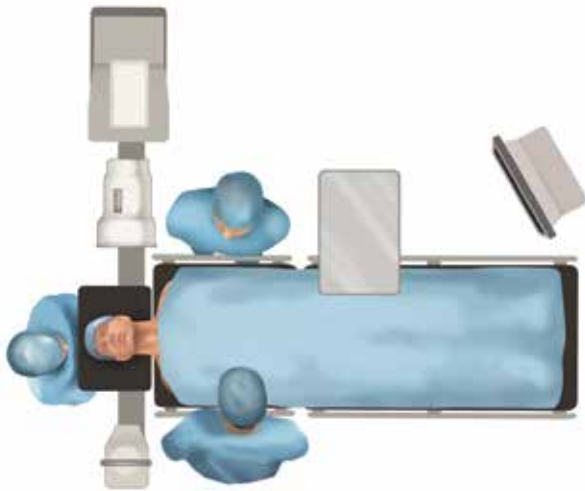

Operating Room Setup and Patient Positioning

Patient positioning is critical to ensure proper orientation and alignment of the device. The position should be maintained throughout the surgery, and rotation of the head should be prevented.

- The patient's neck should be positioned and maintained in neutral lordosis to avoid hyperextension. A roll can be used to support the neck's position.
- The chin should be stabilized to align with the sternum with no rotation, using tape or a strap to the bed to maintain the position.
- For surgery involving lower levels (C6/C7), the shoulders should also be taped for better visualization. A footboard can be used to maintain the patient's position.

Proper C-arm set up is critical for accurate visualization of instrument and implant positioning.

- Prepare for C-arm use that allows cephalad and caudad movement.
- Set the C-arm to capture true A/P and lateral views. This should be done during patient positioning and before final draping.
- As the C-arm is moved frequently, consider taping the floor to mark the best C-arm positions to eliminate variations in film view during the case and for time efficiencies.
- Use C-arm to confirm targeted disc level.

Surgery Approach and Procedure

The Mobi-C surgical approach is identical to that of a traditional anterior cervical discectomy and fusion (ACDF). However, the Mobi-C surgical procedure emphasizes aspects that may differ from a standard ACDF procedure. The operating surgeon will want to:

- Center the exposure on midline.
- Use a radiolucent retractor.
- Reduce soft tissue trauma by limiting retraction ischemia, minimal dissection of the longus colli, and less electrocautery use.
- Obtain parallel distraction using an interbody distractor to open the posterior aspect of the disc space.
- Complete disc removal without burrs, preserving the bony endplate.

- Decompress the foramen bilaterally.
- Establish a normal, healthy disc height (no overstuffing).
- Place the implant in the center of the vertebral bodies for optimal biomechanical success.

Considerations for a Two-level Surgery

- For patients indicated for a Mobi-C at two levels, use a transverse incision centered between levels. Place a distractor screw (caspar pin; 12 mm [0022-LDR] or 14 mm [0024-LDR]) in the intermediate vertebral body mid-distance between endplates.
- Trial and complete implantation of one level. Repeat the technique on the second level. It may be easier to complete the most diseased level first to ensure adequate height, lordosis and sagittal balance restoration.

DISCECTOMY

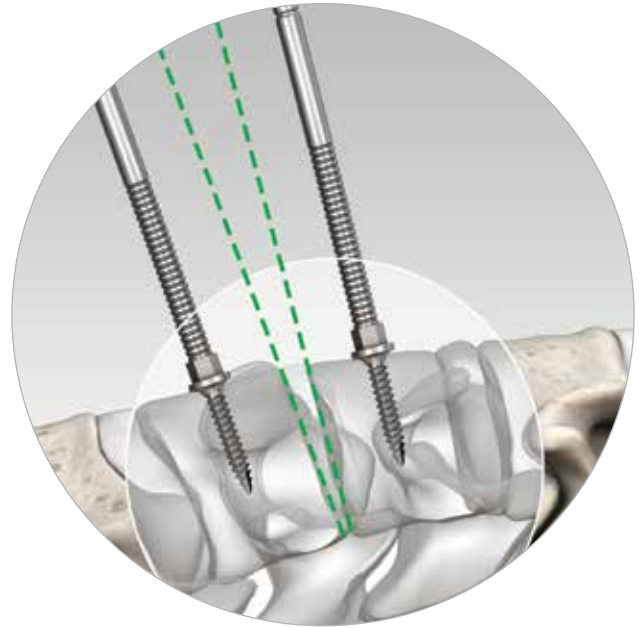
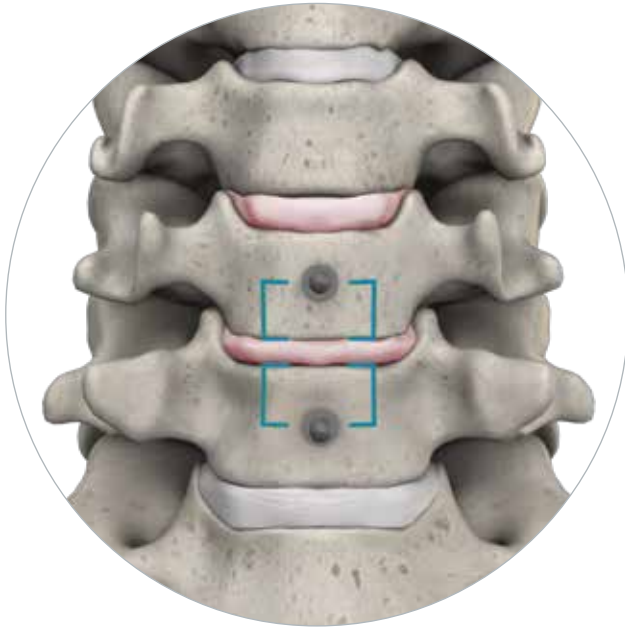

STEP 1

Optional: Centering Pin Placement for Confirmation of Midline

- Position the pin (MB904R; centering pin) on the midline using the pin holder (MB903R) about 5 mm from the inferior edge of the superior vertebral body.
- Use fluoroscopy to confirm proper positioning of the centering pin. Once confirmed, the centering pin can be removed and replaced by a caspar pin using the distraction screwdriver (caspar pin driver; 0114-LDR).

Optional: Level Confirmation with Fluoroscopy

- A pin can be inserted into the affected disc; use fluoroscopy to confirm the appropriate level.

Caspar Pin Placement

- If the optional centering pin was not used, select the caspar pin length: 12 mm (0022-LDR) or 14 mm (0024-LDR). Caspar pins are available sterile packed with 2 per box.
- Insert the caspar pin using the caspar pin driver. It is important to place the pins in the following manner:
 - No less than 5 mm from each endplate so as not to interfere with future instrumentation
 - Centered on midline in the coronal plane
 - **Parallel with the vertebral endplates to ensure parallel distraction**
 - Under fluoroscopy to confirm proper positioning

Important: Compared with ACDF, centering the implant in both the sagittal and coronal plane in relation to the vertebral bodies is important for biomechanical success. Use midline placement of the caspar pin as a visual reference for midline device placement.

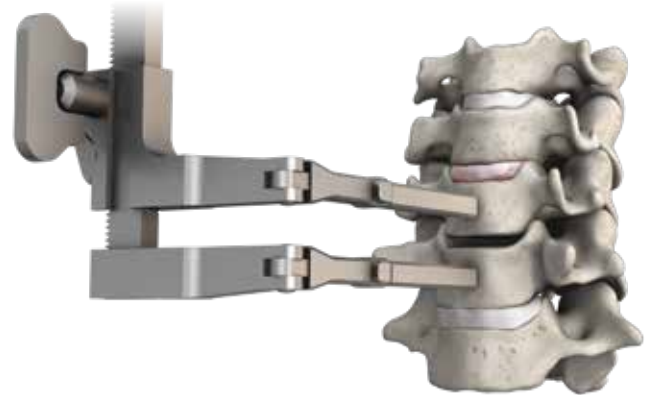
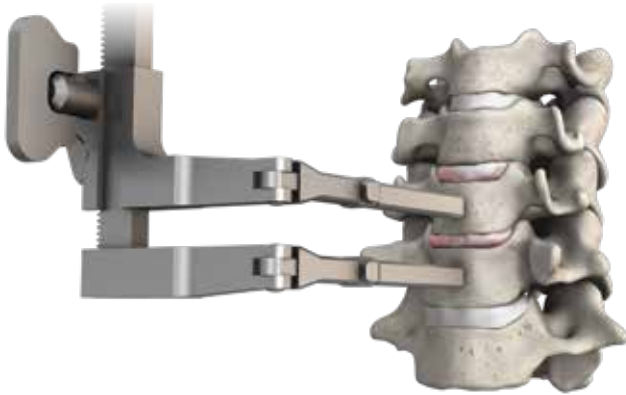

Attach Caspar Distractor

- Select the locking distractor (caspar distractor) 80 mm arm length in either a left or right orientation. Slide the caspar distractor onto the caspar pins and press the locking/unlocking buttons to secure.
- Rotate the knob on the caspar distractor to distract to the desired height for performing the discectomy; ratcheting mechanism maintains height.

STEP 2

Complete Discectomy

- Perform a complete discectomy of the disc space between the uncinete processes and back to the posterior ligament. Take care to decompress the foramen bilaterally and respect the bony endplates.

Note: *If needed for decompression, remodel the posterior uncinete process, and leave a remainder for endplate integrity and segment stability.*

Note: *Release of posterior longitudinal ligament (PLL) may help to obtain parallel distraction. Release should be bilaterally symmetrical. The extent of decompression is left to surgeon discretion based on patient pathology and history.*

- Manually remove all posterior osteophytes on the superior and inferior vertebral endplates. As needed, address large, significant anterior osteophytes.
- Liberally cover any bleeding bone with bone wax to help prevent heterotopic ossification. To prevent weakening of the endplates, use of a burr is discouraged during endplate preparation.
- Use the caspar distractor as needed to maintain or modify distraction.

DISTRACTION

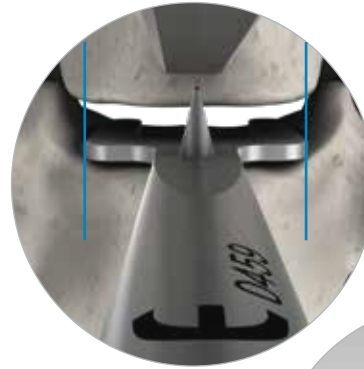
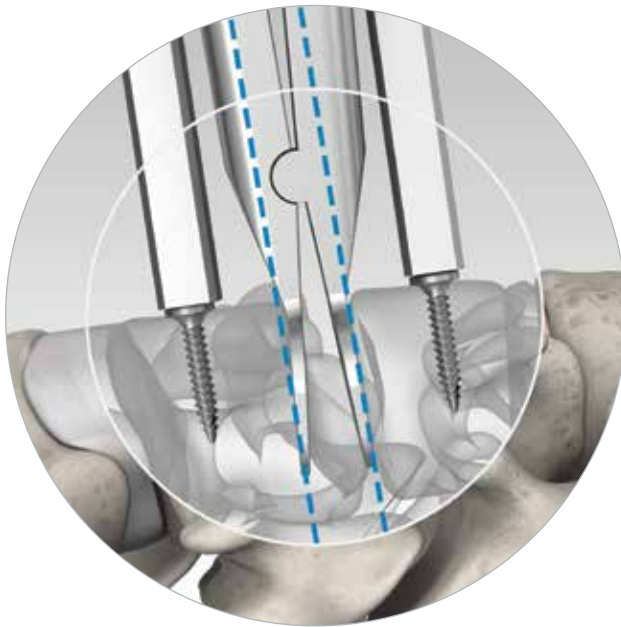

Not to be used
as a depth stop

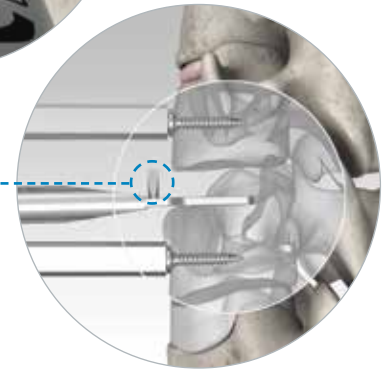

STEP 3

Parallel Distraction

- Insert the distraction forceps (paddle distractor; MB900R) to the back of the disc space. Paddles are 15 mm in depth and can be used to estimate trial depth. Release the caspar distractor.

Note: Rigid distraction forceps (paddle distractors [MB9074R]) are available for difficult to distract discs.

- Use the paddle distractor to create parallel distraction. (caspar distraction alone may not properly distract posteriorly). When the desired height is obtained, lock the caspar distractor to hold distraction.
- Remove the paddle distractor.

Important: It is important to achieve parallel distraction. Use the caspar distractor to maintain the parallel distraction achieved by the paddle distractor.

STEP 4

Width Determination

- Insert the width gauge into the disc space under lateral fluoroscopy. Width gauges correspond to the implant widths of 15, 17 and 19 mm. Position the width gauge flat on the inferior endplate in contact with the base of the uncus bilaterally.

Note: The center reference point, located on the width gauge, confirms location of the vertebral midline; it is not a depth stop and should not come in contact with the anterior face of the vertebra.

- Shape uncus as needed.
- If the width gauge can be moved side-to-side more than 2 mm, trial the next larger width.

TRIALING



IMPLANT FOOTPRINTS INCLUDE (mm)

DEPTH	13	13	15	15	15	17	17
WIDTH	15	17	15	17	19	17	19

STEP 5

Depth Measurement

Estimate the disc depth under fluoroscopy,* based on the:

- Caspar pin depth (12 mm and 14 mm)
- Paddle distractor depth (15 mm)

A depth gauge (MB906R-1, MB906R-2) is available for depth measurement. Place the hook of the gauge over the posterior edge of the vertebral endplates.

Important: It is extremely important to choose a size that achieves complete A/P coverage.

Note: Do not include anterior osteophyte(s) in judgment of depth.

STEP 6

Trial Selection

The depth and width measurements previously taken help to determine the trial size to use. The trial will determine the final implant height to be used as well as implant footprint (width and depth). Each footprint size is color coded by width and there is one trial for every size (footprint/height).

Heights are available in 5, 6 and 7 mm. Trialing should begin with the smallest height first (5 mm) and should not exceed the height of healthy adjacent discs.

*Do not include anterior osteophyte(s) in judgment of depth.

TRIALING (Continued)

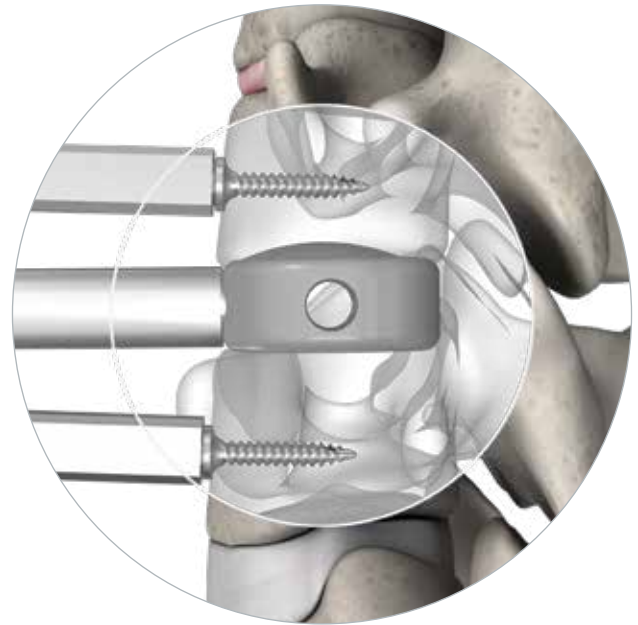

STEP 7

Trial Assembly to the Trial Implant Holder

- To assemble the trial, align and insert the tabs on the distal end of the trial implant holder (MB917R-1, MB917R-2) with the matching groove and hole on anterior face of the trial. To secure, thread the internal rod of the holder into the trial by turning the knob clockwise at the end of the holder.

STEP 8

Implant Trialing

- With the caspar distractor in slight distraction, gently tap the trial under fluoroscopy into the disc space until the superior dome of the trial is positioned centrally and mated with the dome of the superior vertebrae. Take care not to advance trial beyond the posterior margin of the vertebral body.

Important: Confirm the complete anterior-posterior and medial-lateral endplate coverage of the selected footprint.



- Release the caspar distractor to assess the tension and fit. Once released, take a lateral X-ray to validate height and depth selection and an A/P X-ray to assess central placement and width. The holes in the trial, front and side facilitate verification of position (center and rotation). In assessing the trial fit:
 - Start with a 5 mm trial (over 85% of implanted Mobi-Cs are 5 mm, rarely a 7 mm).
 - Do not overstuff height.
 - Reference healthy adjacent levels and facets.

Note: *If the inferior endplate of the superior vertebra is flat, use a curette to prepare room for the dome of the device.*

Note: *The trial implant holder can be removed to take an unobstructed A/P X-ray, then re-engaged for trial removal.*

- To remove the trial, put the caspar distractor back into slight distraction.

MOBI-C INSERTION

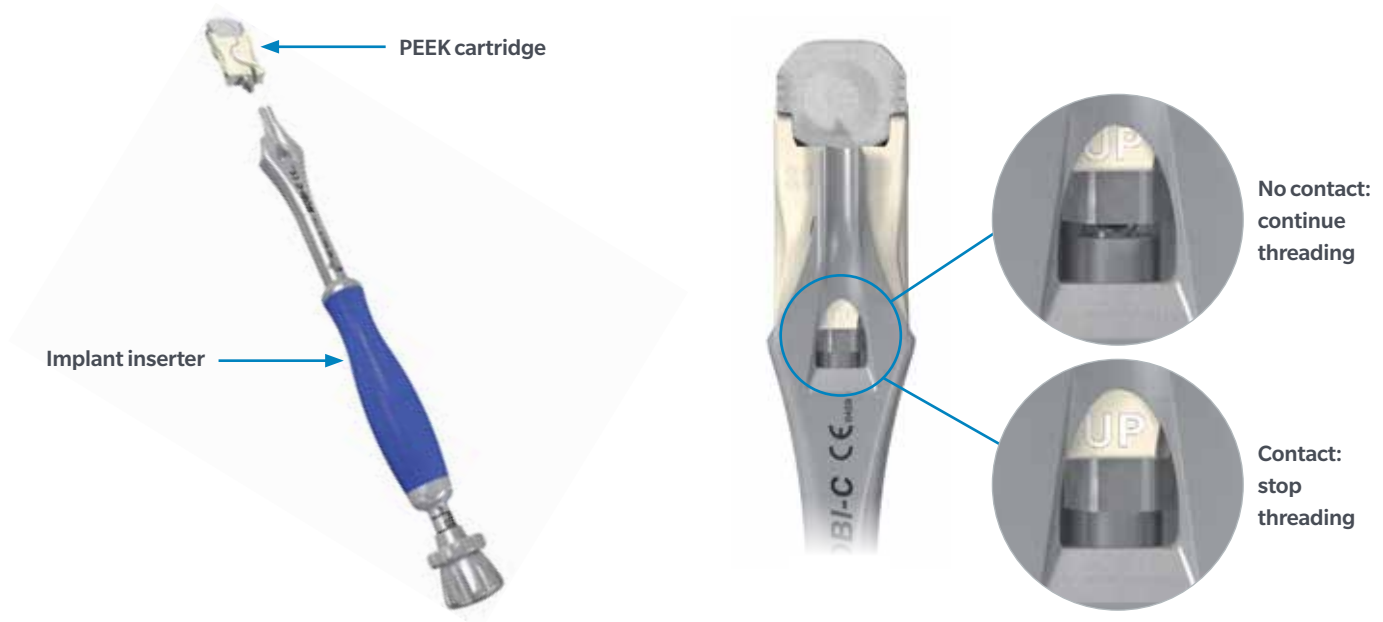

STEP 9

Implant Assembly to the Implant Inserter

Important: Visually inspect the implant assembly while loading to the universal inserter (implant inserter; MB9001R-1, MB9001R-2, MB9001R-3). If any part of the implant or PEEK cartridge is damaged or unassembled, do not use. It is normal to have a little movement in the implant attachment to the PEEK cartridge, particularly in the superior endplate.

- Load the preassembled implant assembly onto the implant inserter. Turn the impaction knob on the implant inserter until the cartridge screw is completely threaded onto, and just in contact with the implant inserter.

Important: Take care to stop threading as soon as full contact is achieved to avoid premature opening of the PEEK cartridge and releasing the implant.

- Visual control of contact can be confirmed using the window on the implant inserter. The word “UP,” indicating the top of the device, becomes completely visible when the correct position is obtained.

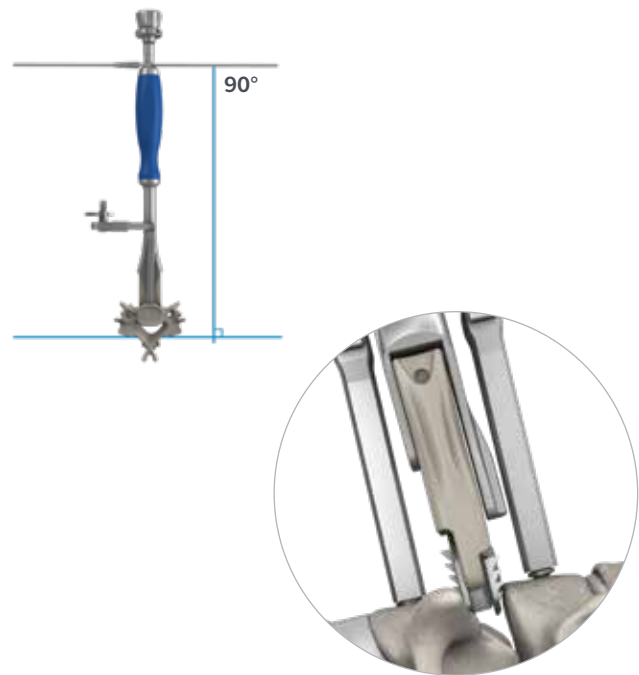
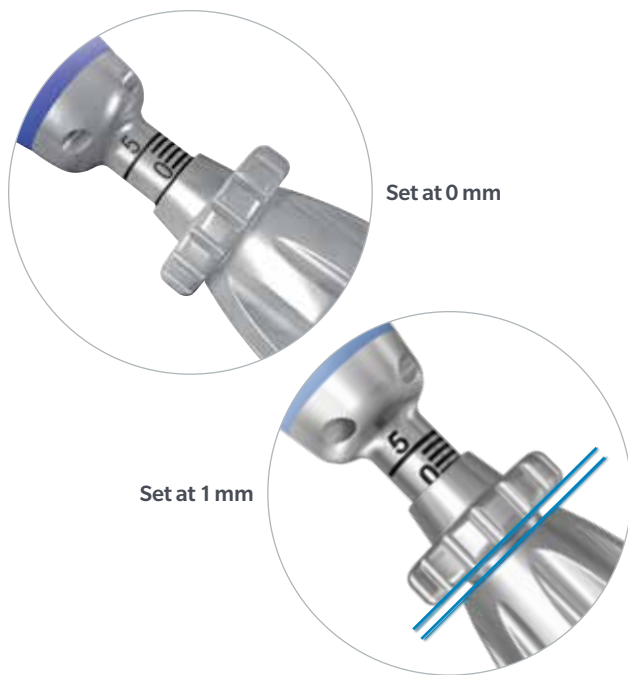

Depth Stop Adjustment

- The implant inserter has a depth stop adjustment collar, which should be set initially at zero. A zero setting will place the anterior edge of the implant flush with the anterior aspect of the vertebral body. The depth stop allows for setting the insertion depth of the device from 0 to 5 mm.
- The stop adjustment is indexed, one full turn (360°) equals 1 mm. At each full turn of the depth stop collar, there is a tactile feel of the ball detent dropping into a groove.

STEP 10

Verify Insertion Trajectory

- Position the implant inserter in the A/P axis of the disc. This position can be verified visually; the groove on the implant inserter should align with midline.
- To verify the correct position and axial rotation about the transverse plane of the implant inserter, use the inserter level (MB9072R).
- The inserter level should be parallel to the operating room table. It is important to set the correct axial rotation before impacting the device into the disc space. Axial rotation maneuvers of the device should be avoided once the device is in the disc space.

MOBI-C INSERTION (Continued)

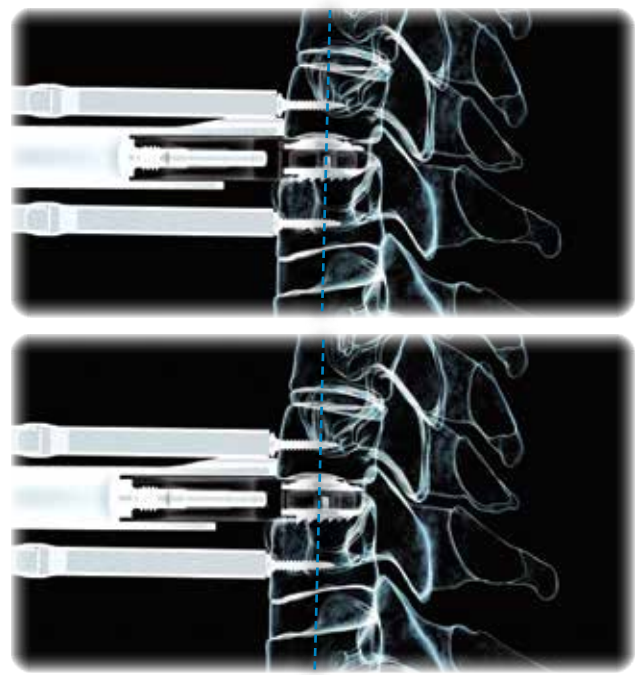

STEP 11

Device Insertion

- Under fluoroscopy, insert the device progressively into the disc space by tapping lightly on the implant inserter's impaction knob with a mallet until the device is centered on the vertebrae anterior-posterior and medial-lateral. The implant should be centered, regardless of endplate coverage.

Note: Take care to center the device on the vertebral endplate.

- During and after insertion, avoid lateral and rotational movements of the implant-to-PEEK cartridge assembly.

Important: If reinsertion is needed, check implant assembly to PEEK cartridge before reinsertion. If at any time prior to achieving final position the implant comes apart from the PEEK cartridge, do not attempt to reassemble. Select and use a new preassembled implant.

STEP 12

Position Verification — Lateral View

- Use fluoroscopy to assess implant position. Release the caspar distractor to permit the vertebral endplates to align in parallel.
- From the lateral view, assess the implant's A/P position. If necessary, the posterior position of the device in the intervertebral space can be adjusted. Adjust the implant inserter's depth stop knob. Mallet lightly on the implant inserter's impaction knob until the desired posterior position is achieved. The implant should be centered.
- The alignment of the tabs on the inferior plate is used to assess the position of the device in rotation. Two tabs can be seen if the device is rotated. If necessary to correct a rotated device or for lateral implant adjustments, distraction of the disc space is required to prevent implant-to-PEEK cartridge disassembly *in situ*.

Note: Use the anterior aspect of the tab to locate midline on the endplates.

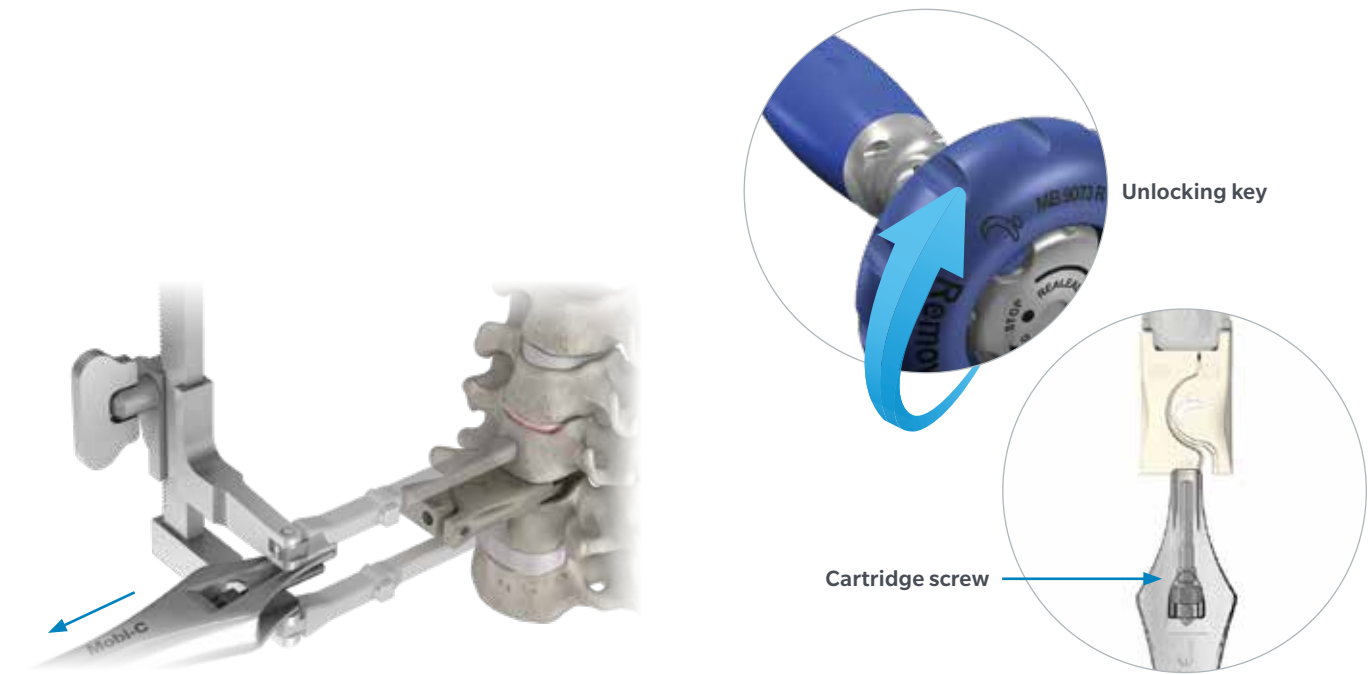

STEP 13

Implant Inserter Removal

- Once optimal device position is confirmed and the caspar distractor is released, apply initial compression with caspar distractor to set the lateral implant teeth into the bone. This will help keep the device in place during PEEK cartridge disassembly and removal.
- Turn the implant inserter impaction knob clockwise with the help of the unlocking key (MB9073R) to release the cartridge screw. Turn unlocking key approximately 20 times to fully release the screw from the PEEK cartridge.

Note: Never use the unlocking key while loading the device.

- The removal of the cartridge screw releases the PEEK cartridge, allowing the implant inserter to be disengaged from the cartridge. Carefully remove the implant inserter in a straight line. Take care not to move the implant.

Important: Continue to turn until the cartridge screw is completely released from the PEEK cartridge.

REMOVAL OF PEEK CARTRIDGE AND POSITION ASSESSMENT

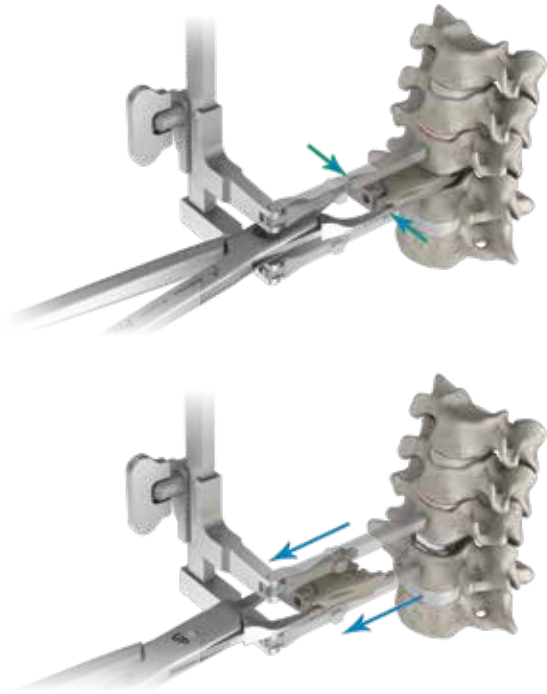

STEP 14

PEEK Cartridge Removal

- Using the extraction forceps (MB9075R), grasp the proximal ends of the two piece PEEK cartridge at the side notches. Take care not to move the implant.
- Squeeze the forceps to release the PEEK cartridge from the implant then extract the cartridge by pulling back the forceps along the axis of the disc. The PEEK cartridge is disposable.

Note: If the PEEK cartridge is difficult to extract, rotate one side of the cartridge 90° caudal, then remove with forceps. Repeat on the remaining side.

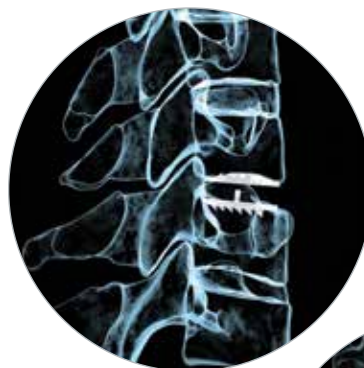
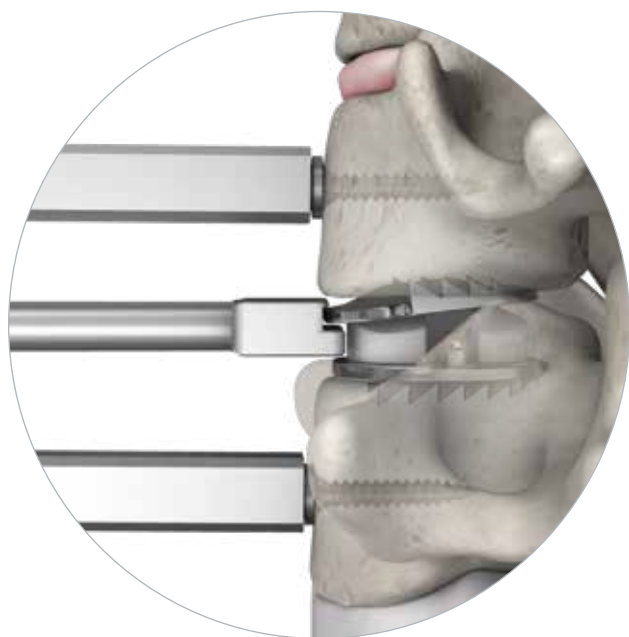

Plate Adjustment

- If after removing the PEEK cartridge, one or both of the plates require adjustment, the plate impactor (tamp; MB942R) can be used to adjust the posterior position of an individual plate. Confirm position under fluoroscopy before and after plate adjustment.
- Orient the longer lip of the tamp toward the anterior face of the mobile polyethylene insert. Gently mallet the handle of the tamp to push the plate posterior.

Final Position Assessment

- A/P and lateral fluoroscopy will confirm correct positioning of the device.

REMOVAL OF PEEK CARTRIDGE AND POSITION ASSESSMENT (*Continued*)

1. Pull back handle to seat screw.

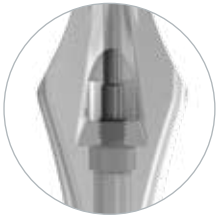

2. Rotate handle counterclockwise.



3. Separate screw from inserter.

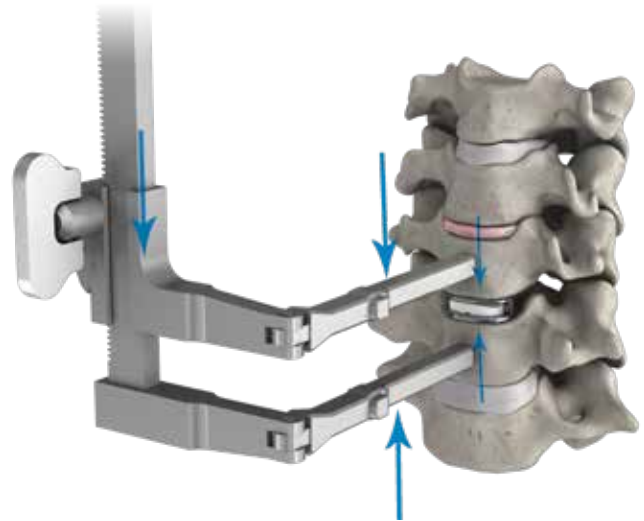
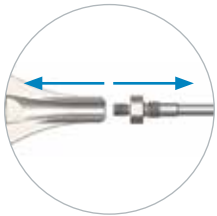

STEP 15

Removal of Cartridge Screw

- Remove and dispose of the cartridge screw by pulling back and unscrewing counterclockwise the implant inserter's impaction knob. Removal of the cartridge screw is required for cleaning and in two-level cases for the attachment of a new PEEK cartridge to the implant inserter.

STEP 16

Final Vertebral Compression

- Once final position is confirmed, apply firm compression using the caspar distractor to seat the implant teeth into the vertebrae. In a two-level case, perform compression at each level separately.
- Once the compression is achieved, remove the caspar distractor.
- Remove all the caspar pins. Place bone wax as needed in the holes created by the pins to reduce bleeding and on any anterior bone surfaces exposed during osteophyte removal.

SECOND IMPLANT INSERTION

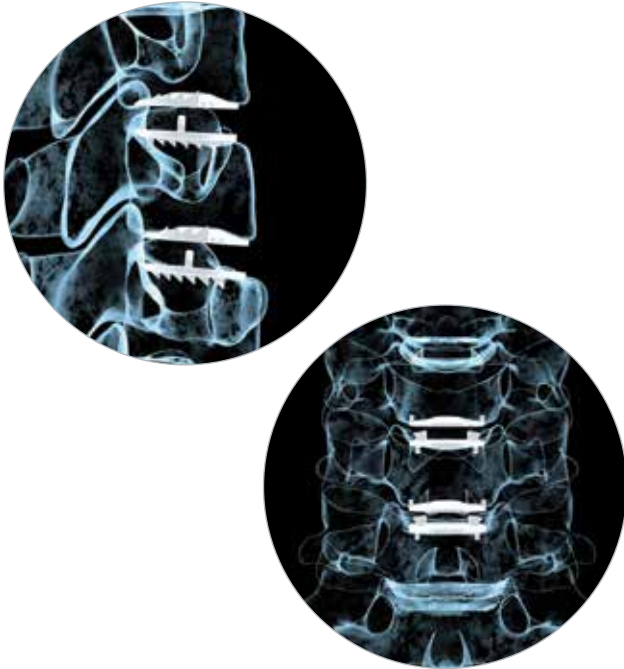

Optional

- For patients indicated for a Mobi-C at two levels, the following steps assume the trialing and completed insertion of one level.
- Leave the caspar pin in the middle vertebral body and move the most inferior or superior pin to the opposite most inferior or superior vertebral body. Then repeat the steps described previously in this document for insertion of the first Mobi-C implant.
- Attach the caspar distractor to the pins and distract to access the second disc.
- Complete the discectomy.
- Measure the width and depth.
- Trial to determine the height and final implant size.
- Assemble a Mobi-C to the implant inserter.
- Insert the Mobi-C.
- Verify the implant's position via radiographic visualization.
- Apply light caspar distractor compression and then remove the implant inserter and the PEEK cartridge.
- Assess final position of both implants via radiographic visualization.
- Apply firm vertebral compression with the caspar distractor to seat the implant teeth into the vertebrae.

IMPLANT REMOVAL FOR REVISION

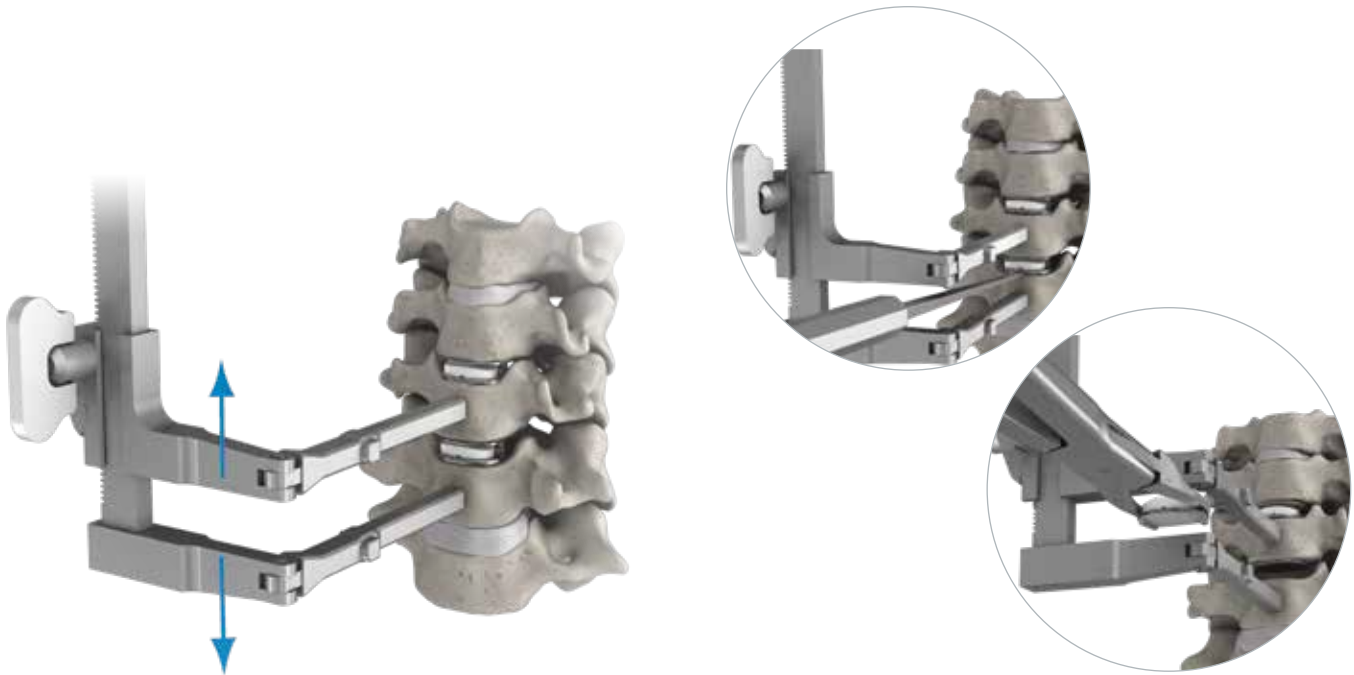

Distraction

- Centrally insert caspar pins above and below both endplates. Attach the caspar distractor to the pins and distract using the knob; ratcheting mechanism maintains height. Take care not to over distract when adjusting the height for implant removal.

Implant Removal

- Using a penfield #4 or thin osteotome, loosen the inferior bone-to-implant interface.
- Hook the tips of the extraction forceps (MB9075R) posterior to the tabs on the inferior plate. Remove the inferior plate and mobile insert together, taking care to stay in the axis of the intervertebral space.

POSTOPERATIVE MANAGEMENT



Implant Removal (*Continued*)

- Using a penfield #4 or thin osteotome, loosen the superior bone-to-implant interface. Grab the anterior edge of the superior plate using a needle holder. Remove the plate from the disc space.

Common Postoperative Practices for Patients May Include:

- Ambulate the day of surgery.
- Discharge, based on surgeon preference, often the first day postoperatively.
- Prescribe a soft collar, based on surgeon preference.
- Recommend short-term NSAID use postoperatively.³
- Back to office work in 1–2 weeks.
- Physical therapy:
 - Isometric strengthening typically at 2 weeks.
 - Dynamic range of motion at 6 weeks as needed.
- Restrict overhead activity, repetitive neck movements and heavy lifting for 6 weeks.

IMPLANT KIT

DESCRIPTION	PART NUMBER
Mobi-C 13 mm × 15 mm (H5)	MB3355
Mobi-C 13 mm × 15 mm (H6)	MB3356
Mobi-C 13 mm × 15 mm (H7)	MB3357
Mobi-C 13 mm × 17 mm (H5)	MB3375
Mobi-C 13 mm × 17 mm (H6)	MB3376
Mobi-C 13 mm × 17 mm (H7)	MB3377
Mobi-C 15 mm × 15 mm (H5)	MB3555
Mobi-C 15 mm × 15 mm (H6)	MB3556
Mobi-C 15 mm × 15 mm (H7)	MB3557
Mobi-C 15 mm × 17 mm (H5)	MB3575
Mobi-C 15 mm × 17 mm (H6)	MB3576
Mobi-C 15 mm × 17 mm (H7)	MB3577
Mobi-C 15 mm × 19 mm (H5)	MB3595
Mobi-C 15 mm × 19 mm (H6)	MB3596
Mobi-C 15 mm × 19 mm (H7)	MB3597
Mobi-C 17 mm × 17 mm (H5)	MB3775
Mobi-C 17 mm × 17 mm (H6)	MB3776
Mobi-C 17 mm × 17 mm (H7)	MB3777
Mobi-C 17 mm × 19 mm (H5)	MB3795
Mobi-C 17 mm × 19 mm (H6)	MB3796
Mobi-C 17 mm × 19 mm (H7)	MB3797



INSTRUMENT SET

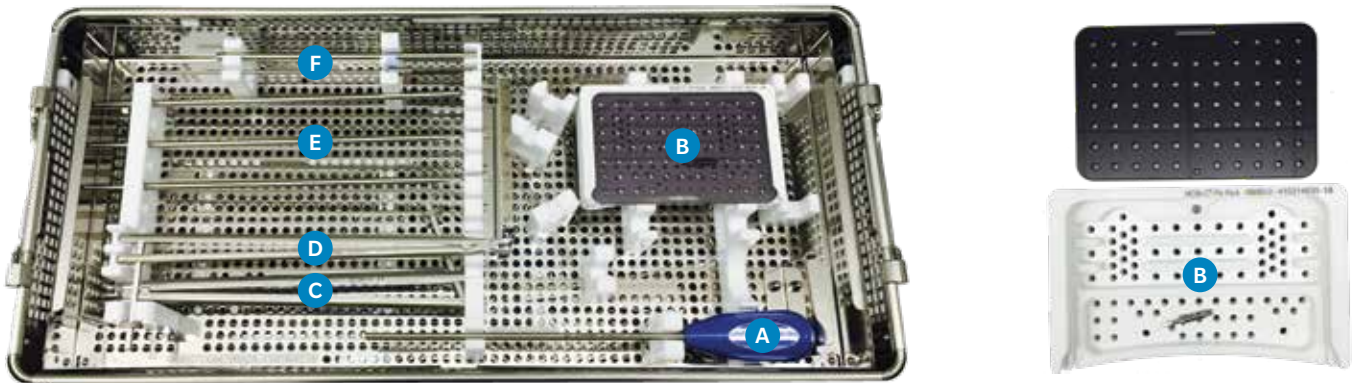

MB992 Instrument Case (Instruments Included)

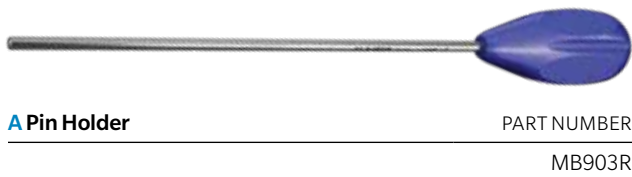

A Pin Holder PART NUMBER
MB903R

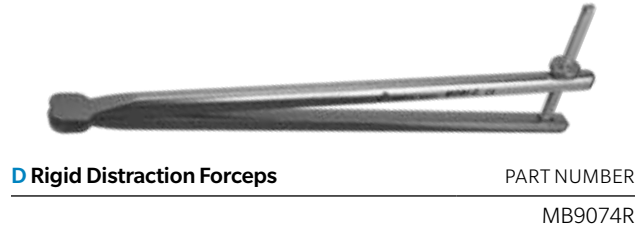

D Rigid Distraction Forceps PART NUMBER
MB9074R



B Pin Rack: Pin PART NUMBER
MB904R

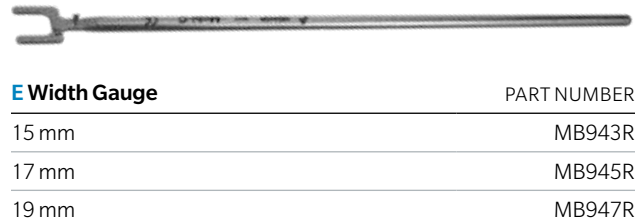

E Width Gauge PART NUMBER
15 mm MB943R
17 mm MB945R
19 mm MB947R

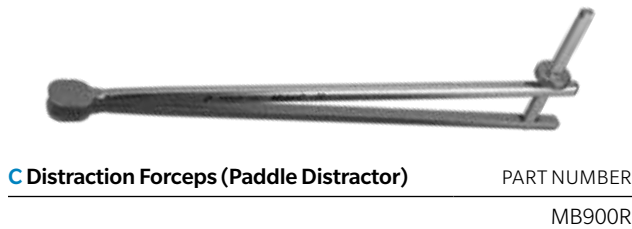

C Distraction Forceps (Paddle Distractor) PART NUMBER
MB900R

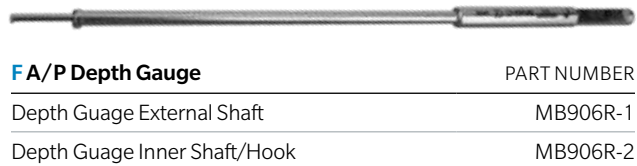

F A/P Depth Gauge PART NUMBER
Depth Gauge External Shaft MB906R-1
Depth Gauge Inner Shaft/Hook MB906R-2

MOBI-C: INSTRUMENT SET (Continued)

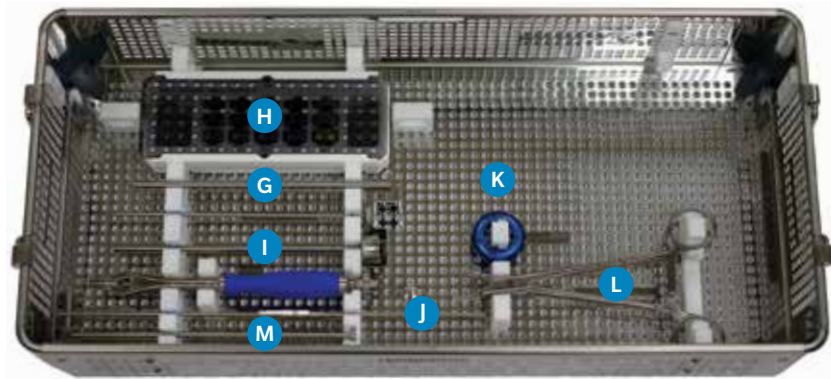

G Trial Implant Holder	PART NUMBER
Trial Implant Holder Outer Shaft	MB917R-1
Trial Implant Holder Inner Shaft	MB917R-2



H Trials	PART NUMBER
13 mm × 15 mm (H5)	MB9008R
13 mm × 15 mm (H6)	MB9009R
13 mm × 15 mm (H7)	MB9010R
13 mm × 17 mm (H5)	MB9023R
13 mm × 17 mm (H6)	MB9024R
13 mm × 17 mm (H7)	MB9025R
15 mm × 15 mm (H5)	MB9018R
15 mm × 15 mm (H6)	MB9019R
15 mm × 15 mm (H7)	MB9020R
15 mm × 17 mm (H5)	MB9033R
15 mm × 17 mm (H6)	MB9034R
15 mm × 17 mm (H7)	MB9035R
15 mm × 19 mm (H5)	MB9048R
15 mm × 19 mm (H6)	MB9049R
15 mm × 19 mm (H7)	MB9050R
17 mm × 17 mm (H5)	MB9043R
17 mm × 17 mm (H6)	MB9044R
17 mm × 17 mm (H7)	MB9045R
17 mm × 19 mm (H5)	MB9058R
17 mm × 19 mm (H6)	MB9059R
17 mm × 19 mm (H7)	MB9060R



I Universal Inserter (Implant Inserter)	PART NUMBER
Implant Holder Body	MB9001R-1
Implant Holder Inner Shaft	MB9001R-2
Implant Holder Depth Knob	MB9001R-3



J Inserter Level	PART NUMBER
	MB9072R



K Unlocking Key	PART NUMBER
	MB9073R



L Extraction Forceps	PART NUMBER
	MB9075R



M Plate Impactor (Tamp)	PART NUMBER
	MB942R

INSTRUMENT SET: CERVICAL DISTRACTION SYSTEM

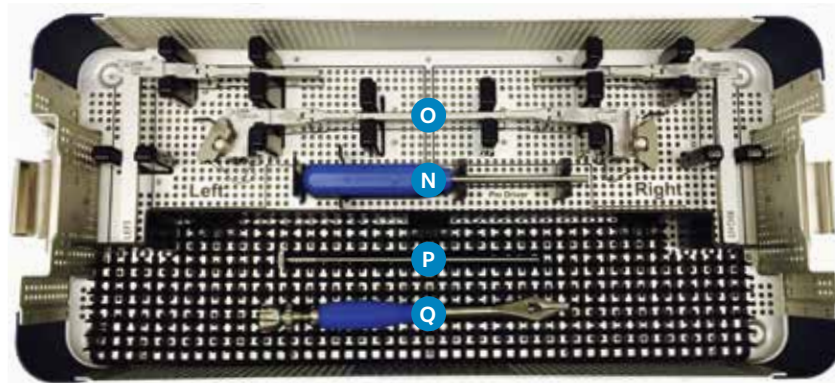

CDIST-2014 Instrument Case



N Distraction Screw Driver (Caspar Pin Driver) PART NUMBER
0114-LDR



O Locking Distractor Screws (Caspar Distractor) with 80 mm Hinged Arms PART NUMBER
Right 0138-LDR
Left 0139-LDR



12 mm Distraction Screws (Caspar Pins) PART NUMBER
2 per box (sterile packed) 0022-LDR



14 mm Distraction Screws (Caspar Pins) PART NUMBER
2 per box (sterile packed) 0024-LDR



P Trial Implant Holder PART NUMBER
Implant Trial Holder Outer Shaft MB917R-1
Implant Holder Inner Shaft MB917R-2



Q Universal Inserter (Implant Inserter) PART NUMBER
Implant Holder Body MB9001R-1
Implant Holder Inner Shaft MB9001R-2
Implant Holder Depth Knob MB9001R-3

IMPORTANT INFORMATION ON THE MOBI-C CERVICAL DISC

Device Description

The Mobi-C Cervical Disc Prosthesis (Mobi-C) is a single-use device for cervical intervertebral disc replacement at one level or two contiguous levels from C3 to C7 designed to maintain/restore segmental motion and disc height. The components of the Mobi-C include a cobalt, chromium, molybdenum (CoCrMo per ISO 5832-12) alloy superior spinal plate, an inferior CoCrMo spinal plate and an ultra-high-molecular-weight polyethylene (UHMWPE per ISO 5834-2) mobile insert. The inner contact surfaces of the superior and inferior spinal plates are spherical and flat, respectively. This allows for fully congruent contact surfaces between the spinal plates and mobile insert. The two lateral stops of the inferior plate are designed to control and limit the mobility of the mobile insert. The spinal plates, both superior and inferior, feature two rows of teeth which are designed to aid in initial and long term fixation and stability. A titanium (per ASTM F1580) and hydroxyapatite (per ISO 13779) plasma spray coating is applied to the bony interface surfaces of the superior and inferior spinal plates.

Indications

The Mobi-C Cervical Disc Prosthesis is indicated in skeletally mature patients for reconstruction of the disc from C3 to C7 following discectomy at one level or two contiguous levels for intractable radiculopathy (arm pain and/or neurological deficit) with or without neck pain, or myelopathy due to abnormality localized to the level of the disc space and at least one of the following conditions confirmed by radiographic imaging (CT, MRI or X-rays): herniated nucleus pulposus, spondylosis (defined by the presence of osteophytes), and/or visible loss of disc height compared to adjacent levels. The Mobi-C Cervical Disc Prosthesis is implanted using an anterior approach. Patients should have failed at least 6 weeks of conservative treatment or demonstrated progressive signs or symptoms despite nonoperative treatment prior to implantation of the Mobi-C Cervical Disc.

Contraindications

The Mobi-C Cervical Disc Prosthesis should not be implanted in patients with the following conditions:

- Acute or chronic infection, systemic or at the operative site
- Known allergy or sensitivity to the implant materials (cobalt, chromium, molybdenum, titanium, hydroxyapatite or polyethylene)
- Compromised vertebral bodies at the index level due to previous trauma to the cervical spine or to significant cervical anatomical deformity or disease (e.g., ankylosing spondylitis, rheumatoid arthritis)
- Marked cervical instability on resting lateral or flexion/extension radiographs demonstrated by translation greater than 3.5 mm, and/or > 11° angular difference to that of either adjacent level
- Osteoporosis or osteopenia defined as DEXA bone mineral density T-score < -1.5
- Severe facet joint disease or degeneration

Warnings

- The Mobi-C Cervical Disc should only be used by surgeons who are experienced with anterior cervical spinal procedures and have undergone hands-on training in the use of this device. Only surgeons who are familiar with the implant components, instruments, procedure, clinical applications, biomechanics, adverse events and risks associated with the Mobi-C Cervical Disc should use this device. A lack of adequate experience and/or training may lead to a higher incidence of adverse events, including neurological complications.
- Correct selection of the appropriate implant size is extremely important to assure the placement and function of the device. Information regarding proper implant size selection, implant site preparation, and the use of the instrumentation before, during and after Mobi-C surgery is provided in the *Mobi-C Surgical Technique Manual* and the *Mobi-C Instrument System Instructions for Use*. Users are advised to read and understand the surgical technique manual and instructions for use prior to surgery.
- Due to the proximity of vascular and neurological structures to the implantation site, there are risks of serious or fatal hemorrhage and risks of neurological damage with the use of the device. Care must be taken to identify and protect these structures.
- Heterotopic ossification (HO) is a potential complication associated with artificial cervical discs and could lead to reduced cervical motion. However, the presence of HO has not been correlated with adverse clinical outcomes involving the Mobi-C Cervical Disc Prosthesis in the G050212 clinical trial.

Precautions

The safety and effectiveness of this device has not been established in patients with the following conditions:

- Skeletally immature patients, pediatric or adolescent children (<21 years old) or those over the age of 67;
- Prior cervical spine surgery, including prior surgery at the index level;

- More than two diseased or immobile cervical spine level requiring surgical intervention;
- Disc height less than 3 mm measured from the center of the disc in a neutral position and disc height less than 20% of the anterior-posterior width of the inferior vertebral body;
- Significant kyphotic deformity or significant reversal of lordosis;
- Active malignancy;
- Paget's disease, osteomalacia or other metabolic bone disease;
- Taking medications known to potentially interfere with bone/soft tissue healing (e.g. steroids);
- Pregnancy;
- Diabetes mellitus requiring daily insulin management;
- Clinical extreme obesity (class III) as defined by the NIH Clinical Guidelines Body Mass Index (i.e. BMI >40);
- Neck or arm pain of unknown etiology;
- Systemic disease including AIDS, HIV and hepatitis;
- Intractable radiculopathy or myelopathy due to pathology at more than two levels and/or pathology not localized to the level of the disc space;
- Prior fusion at an adjacent vertebral level;
- Neck pain alone;
- Rheumatoid arthritis or other autoimmune disease;
- Neuromuscular disorders such as muscular dystrophy, spinal muscular atrophy, or amyotrophic lateral sclerosis;
- Acute mental illness or substance abuse.

Preoperative

- Patient selection is extremely important. In selecting patients for total disc replacement, the following factors can be of importance to the success of the procedure: the patient's occupation or activity level, prior injury or other ongoing illness, alcoholism or drug abuse and certain degenerative diseases (e.g., degenerative scoliosis or ankylosing spondylitis) that may be so advanced at the time of implantation that the expected useful life of the device is substantially decreased.

- In order to minimize the risk of periprosthetic vertebral fractures, surgeons must consider all co-morbidities, past and present medications, previous treatments, etc. A screening questionnaire for osteopenia or osteoporosis, SCORE (Simple Calculated Osteoporosis Risk Estimation), may be used to screen patients to determine if a DEXA bone mineral density measurement is necessary. If DEXA is performed, the patient should be excluded from receiving the device if the DEXA bone density measured T score is < -1.5, as the patient may be osteoporotic or osteopenic.
- The patient should be informed of the potential adverse effects (risks/complications) contained in the insert (see ADVERSE EVENTS).
- Preoperative planning may be used to estimate the required implant size and to assure that the appropriate range of sizes is available for surgery. The procedure should not take place if the appropriate range of sizes will not be available.
- Examine all instruments prior to surgery for wear or damage. Instruments that have been used excessively may be more likely to break. Replace any worn or damaged instruments.

Intraoperative

- Use aseptic technique when removing the Mobi-C from the innermost packaging. Carefully inspect each component and its packaging for any signs of damage, including damage to the sterile barrier. Do not use Mobi-C implants if the packaging is damaged or the implant shows signs of damage.
- Use care when handling the Mobi-C to ensure that it does not come in contact with objects that could damage the implant. Damaged implants are no longer functionally reliable. Visual inspection of the prosthesis assembly is recommended prior to implanting the device. If any part of the assembly appears damaged or not fully assembled, do not use.
- To prevent unnecessary damage to the bearing surfaces, ensure that tissue or other debris is not trapped within the device.
- The Mobi-C should not be used with components or instruments of spinal systems from other manufacturers. See the surgical technique for step-by-step instructions.
- Surgical implants must never be re-used or re-implanted. Even though the device appears undamaged, it may have small defects and internal stress patterns that can lead to early breakage.

IMPORTANT INFORMATION ON THE MOBI-C CERVICAL DISC (*Continued*)

Intraoperative (*Continued*)

- Perform a complete discectomy of the disc space between the unci and up to the posterior ligament. Take care to release the foramen bilaterally. It is important to remove all anterior and posterior osteophytes on the superior and inferior vertebral endplates. Liberally cover bleeding with bone wax. To prevent weakening of the endplates, use of a burr is discouraged during endplate preparation. Use the caspar retractor as needed to maintain or modify distraction. Ensure proper alignment and placement of device components as misalignment may cause excessive wear and/or early failure of the device.

Postoperative

- Patients should be instructed in postoperative care procedures and should be advised of the importance of adhering to these procedures for successful treatment with the device including the avoidance of heavy lifting, repetitive bending, and prolonged or strenuous activity initially and for a period of weeks to months depending on the individual patient's progress and the stability and functioning of the implant.

Note to physician: *Although the physician is the learned intermediary between the company and the patient, the important medical information given in this document should be conveyed to the patient.*

MRI Safety Information



Non-clinical testing has demonstrated that the Mobi-C Cervical Disc Prosthesis is MR Conditional. A patient with this device can be safely scanned in an MR system meeting the following conditions:

- Static magnetic field of 1.5 and 3.0 Tesla only
- Maximum spatial gradient magnetic field of 970 Gauss/cm (9.7 T/m) or less
- Maximum MR system reported, whole body averaged specific absorption rate (SAR) of 2 W/kg (normal operating mode)

Under the scan conditions defined above, the Mobi-C Cervical Disc Prosthesis is expected to produce a maximum temperature rise of less than 3°C after 15 minutes of continuous scanning.

In non-clinical testing, the image artifact caused by the device extends approximately 29 mm from the Mobi-C Cervical Disc Prosthesis when imaged with a gradient echo pulse sequence and a 3.0 Tesla MRI system.

Product Complaints

Any health care professional (e.g., customer or user of this system) who has complaints or who has experienced any dissatisfaction in the product quality, identity, durability, reliability, safety, effectiveness and/or performance, should notify LDR Spine USA. Further, if any of the implanted system component(s) ever “malfunctions,” (i.e., does not meet any of its performance specifications or otherwise does not perform as intended), or may have caused or contributed to the death or serious injury of a patient, LDR Spine USA should be notified immediately by telephone, fax, or written correspondence. When filing a complaint, please provide the component(s) name and number, lot number(s), your name and address, and the nature of the complaint. Complaints can also be reported directly to Medwatch at <http://www.fda.gov/medwatch>. You will be contacted by LDR Spine USA to provide specific information for an Enhanced Surveillance Study, for specific information regarding your clinical experience regarding the complaint and overall experience with the device. In the event that the Mobi-C device requires removal for any reason, follow the instructions provided below in the device retrieval section.

Device Retrieval

Should it be necessary to explant a Mobi-C Cervical Artificial Disc, please contact LDR Spine USA to receive instructions regarding data collection, including histopathological, mechanical, patient and adverse event information. Please refer to the Mobi-C Cervical Artificial Disc Surgical Technique for step-by-step instructions on the required surgical technique for device retrieval. All explanted devices must be returned to LDR Spine USA for analysis, in a leakproof container, with the date of explantation, explanting surgeon, and any known information regarding initial implantation, reasons for removal, and adverse event information. Please note that the explanted Mobi-C device should be removed as carefully as possible to keep the implant and surrounding tissue intact. Also, please provide descriptive information about the gross appearance of the device in situ, as well as descriptions of the removal methods, (i.e., intact or in pieces). LDR Spine USA will request additional information regarding the reason for removal, patient information, and associated clinical outcomes.

Note: *All implant removals must be reported immediately to LDR Spine USA.*

Note: *Please refer to the Mobi-C Summary of Safety and Effectiveness Data (PMA P110009 and P110002) at www.fda.gov for complete study results.*

Caution: *Federal (U.S.A.) law restricts this device to sale by or on the order of a physician.*

Endnotes:

1. As of July 30, 2013 in the USA.
2. The control group in the Mobi-C IDE clinical trial was ACDF using allograft bone and an anterior cervical plate.

Reference:

3. Tsung-Hsi Tu, MD, et al. *Heterotopic ossification after cervical total disc replacement: determination by CT and effects on clinical outcomes.* *J Neurosurg Spine.* 14:457–465.

Disclaimer: *This document is intended exclusively for physicians and is not intended for laypersons. Information on the products and procedures contained in this document is of a general nature and does not represent and does not constitute medical advice or recommendations. Because this information does not purport to constitute any diagnostic or therapeutic statement with regard to any individual medical case, each patient must be examined and advised individually, and this document does not replace the need for such examination and/or advice in whole or in part.*



Caution: *Federal (USA) law restricts this device to sale by or on the order of a physician. Rx only. Please refer to the package inserts for important product information, including, but not limited to, indications, contraindications, warnings, precautions, adverse effects, and patient counseling information.*

**Manufactured by:**

LDR Medical
Parc d'entreprises du Grand Troyes
Quartier Europe de, Ouest
5 rue de Berlin
10300 Sainte-Savine, France
Adresse postale: CS 80002
10302 Sainte-Savine CEDEX
+33 (0)3 25 82 32 63

Distributed by:

LDR Spine
13785 Research Blvd.,
Suite 200
Austin, TX 78750 USA
+1 512.344.3333



ZIMMER BIOMET
Your progress. Our promise.®

800.447.3625/zimmerbiomet.com

©2018 Zimmer Biomet Spine, Inc. All rights reserved.

All content herein is protected by copyright, trademarks and other intellectual property rights, as applicable, owned by or licensed to Zimmer Biomet Spine, Inc. or its affiliates unless otherwise indicated, and must not be redistributed, duplicated or disclosed, in whole or in part, without the express written consent of Zimmer Biomet Spine. This material is intended for health care professionals, the Zimmer Biomet Spine sales force and authorized representatives. Distribution to any other recipient is prohibited.

MB ST 2 REV D 0718